

# SENSOR (D02-1015-276)

REVISIONS					
ZONE	REV	DESCRIPTION	BY	DATE	APPROVED
	1	REL TO REV 1 PER E-4022	TB	10/5/2010	JBF
	2	REL TO REV 2 PER E-4108	TB	3/8/11	TB
	3	REL TO REV 2 PER E-4141	TB	4/11/11	TB
	A	24V WIRING CHG PER E-4300	TB	10/3/11	TB
	B	DISTANCE BOARD ADDED PER E-4559	TB	02/05/13	TB
	C	ADD SHEET 3 PER E-4668	TB	07/18/13	TB
	D	NEW POWER D I/O CABLE PER E-5002	TB	11/12/14	TB
	E	WIRE COLORS ON D I/O CABLE PER E-5125	TB	1/20/15	MTS
	F	ADDED SHEET 5 PER E5814	TB	11/21/17	MTS

BASE

COVER

(ELECTRO-OPTICS ASSY D02-1014-562)

(HOUSING ASSY D02-1014-614)

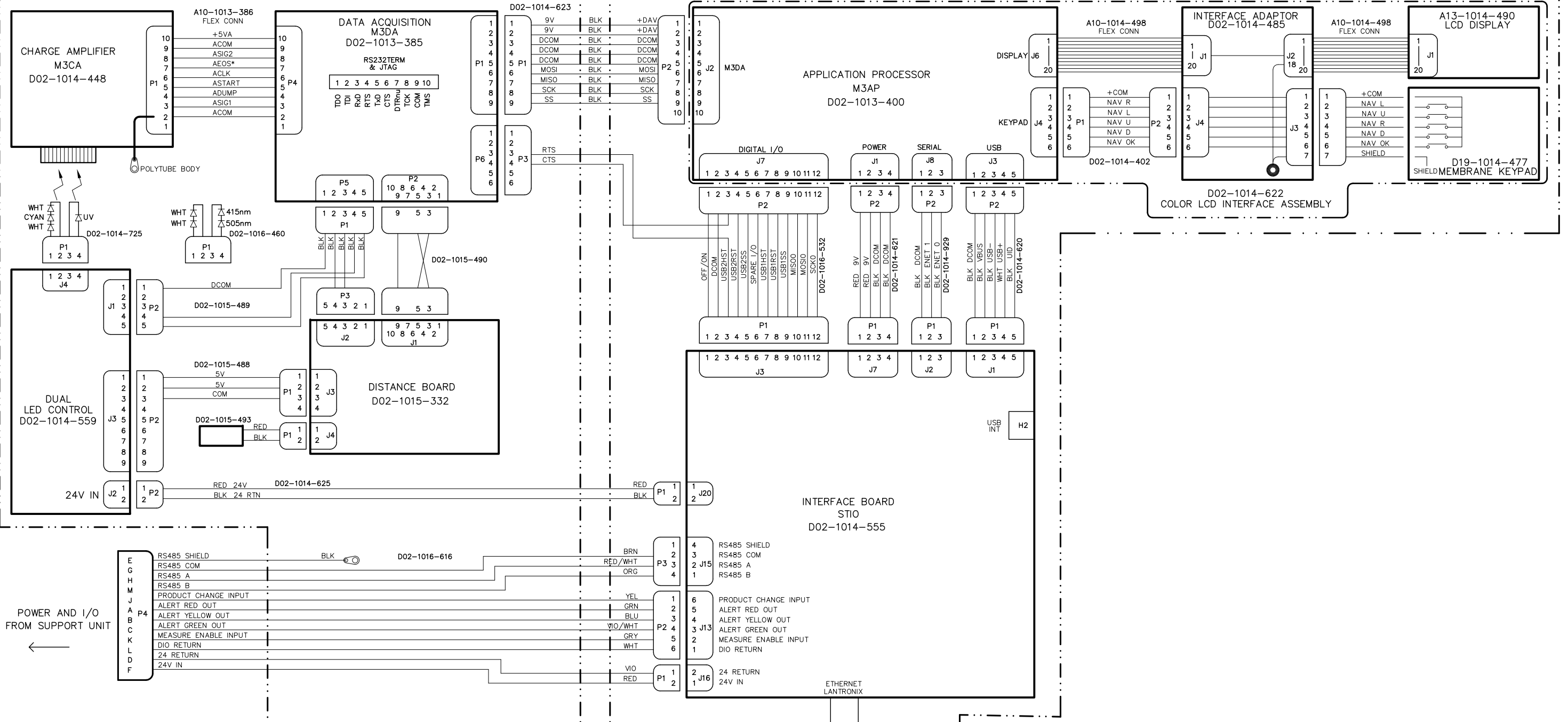

<b>MATERIAL:</b> MATL FINISH: FINISH UNLESS OTHERWISE SPECIFIED: TOLERANCES : 2 PLACE +/- .01 3 PLACE +/- .005 ANGLES +/- 1/2 DO NOT SCALE DRAWING ALL DIMENSIONS ARE IN INCHES DIMENSIONS APPLY AFTER FINISHING REMOVE BURRS AND BREAK SHARP EDGES .005 MAXIMUM INTERPRET DWG PER ANSI Y-14.5 1994		<b>APPROVALS</b> DRAWN TB CHECKED COG ENG PROJ ENG APPR	10/5/10 DATE  DATE  DATE	<b>HunterLab</b> 11491 Sunset Hills Road Reston, VA. 20190 www.HunterLab.com 703-471-6870
<b>INTERCONNECT DIAGRAM, STHT</b>				
SIZE D DWG No. 03-1014-628 SCALE: NONE FILE: 14628E1F	REV F WT: LBS SHEET_1_OF_5			

D 03-1014-628 F SHT\_1\_OF\_5

# SUPPORT UNIT W/O OPTIONS

(STANDARD VERSION D02-1014-823)

REVISIONS				
ZONE	REV	DESCRIPTION	DATE	APPROVED
		SEE SHEET 1 FOR REVISION DESCRIPTION		

COVER

BASE

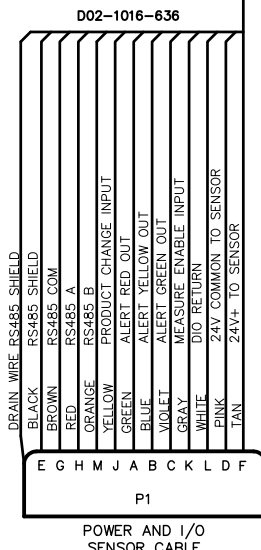
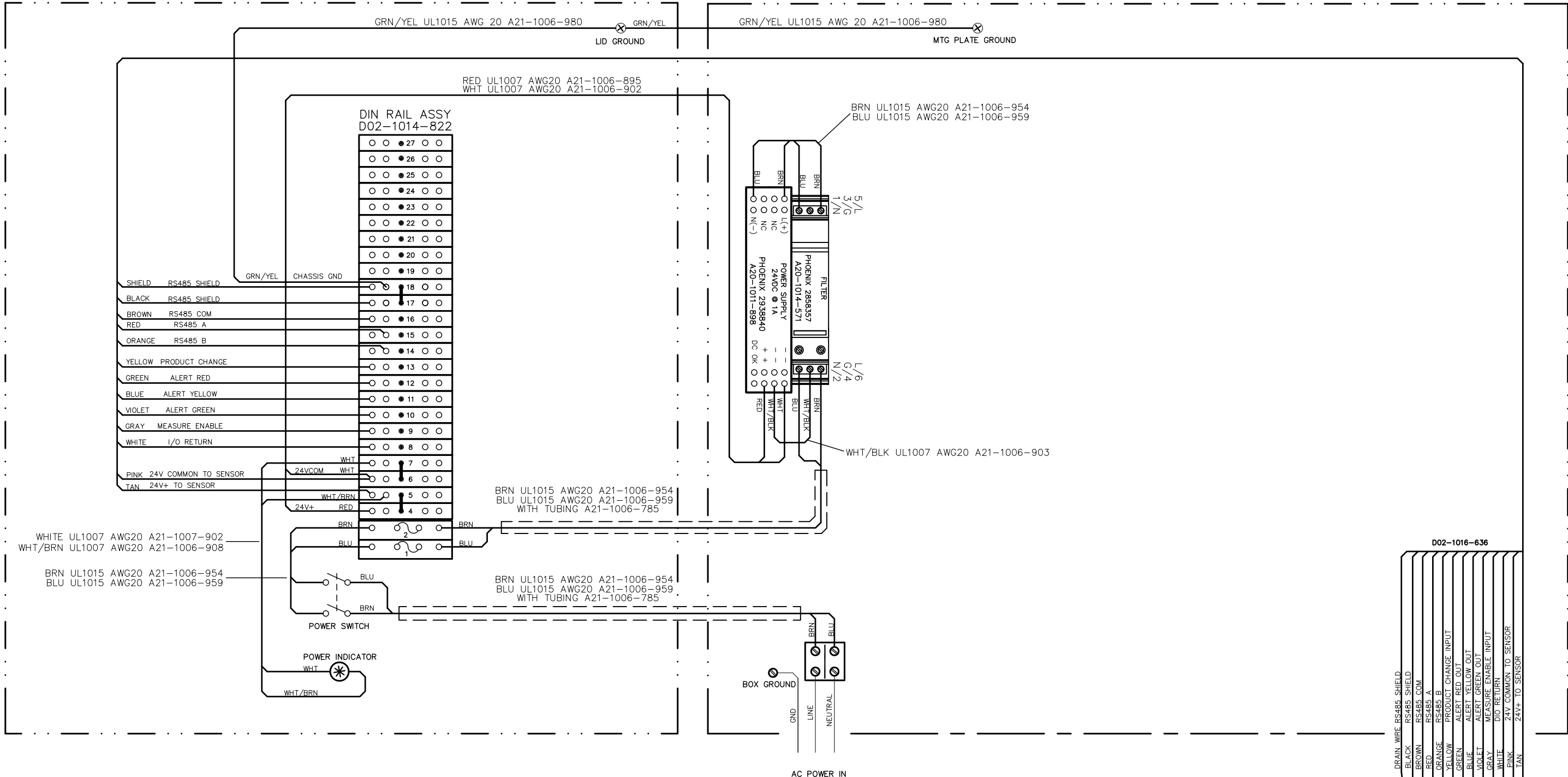

# SUPPORT UNIT

(STANDARD VERSION D02-1014-823)

REVISIONS				
ZONE	REV	DESCRIPTION	DATE	APPROVED
		SEE SHEET 1 FOR REVISION DESCRIPTION		

COVER

BASE

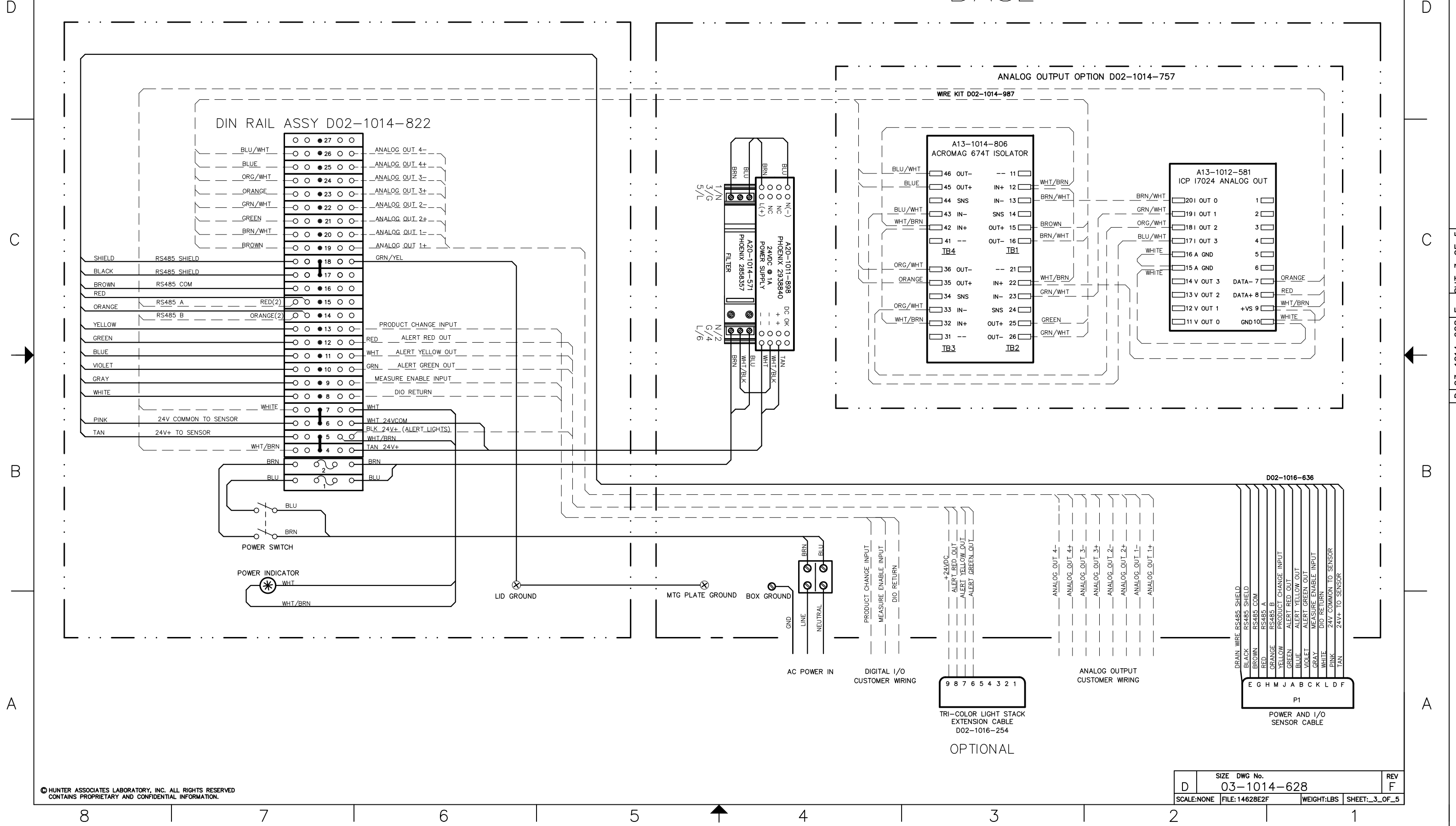

DIN RAIL ASSY D02-1014-822

BLU/WHT	27	ANALOG OUT 4-
BLUE	26	ANALOG OUT 4+
ORG/WHT	25	ANALOG OUT 3-
ORANGE	24	ANALOG OUT 3+
GRN/WHT	23	ANALOG OUT 2-
GREEN	22	ANALOG OUT 2+
BRN/WHT	21	ANALOG OUT 1-
BROWN	20	ANALOG OUT 1+
SHIELD	18	GRN/YEL
BLACK	17	
BROWN	16	
RED	15	
ORANGE	14	PRODUCT CHANGE INPUT
YELLOW	13	RED ALERT RED OUT
GREEN	12	WHT ALERT YELLOW OUT
BLUE	11	GRN ALERT GREEN OUT
VIOLET	10	MEASURE ENABLE INPUT
GRAY	9	DIO RETURN
WHITE	8	WHT
PINK	7	WHT 24VCOM
TAN	6	BLK 24V+ (ALERT LIGHTS)
	5	WHT/BRN
	4	TAN 24V+
	2	BRN
	1	BLU

ANALOG OUTPUT OPTION D02-1014-757

WIRE KIT D02-1014-987

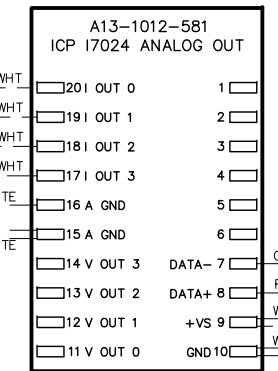
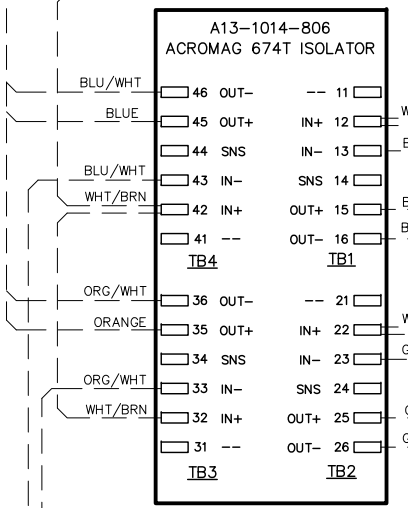

D02-1016-636

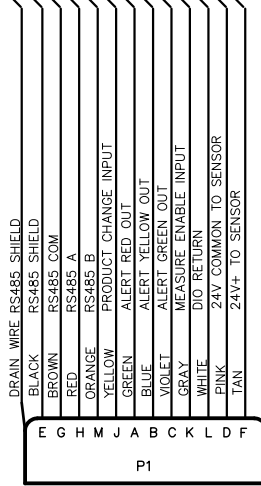

OPTIONAL

TRI-COLOR LIGHT STACK  
EXTENSION CABLE  
D02-1016-254

D 03-1014-628 F SHT\_3\_OF\_5

REVISIONS				
ZONE	REV	DESCRIPTION	DATE	APPROVED
		SEE SHEET 1 FOR REVISION DESCRIPTION		

# SUPPORT UNIT

(STAINLESS STEEL VERSION D02-1016-099 OR 108)

COVER

BASE

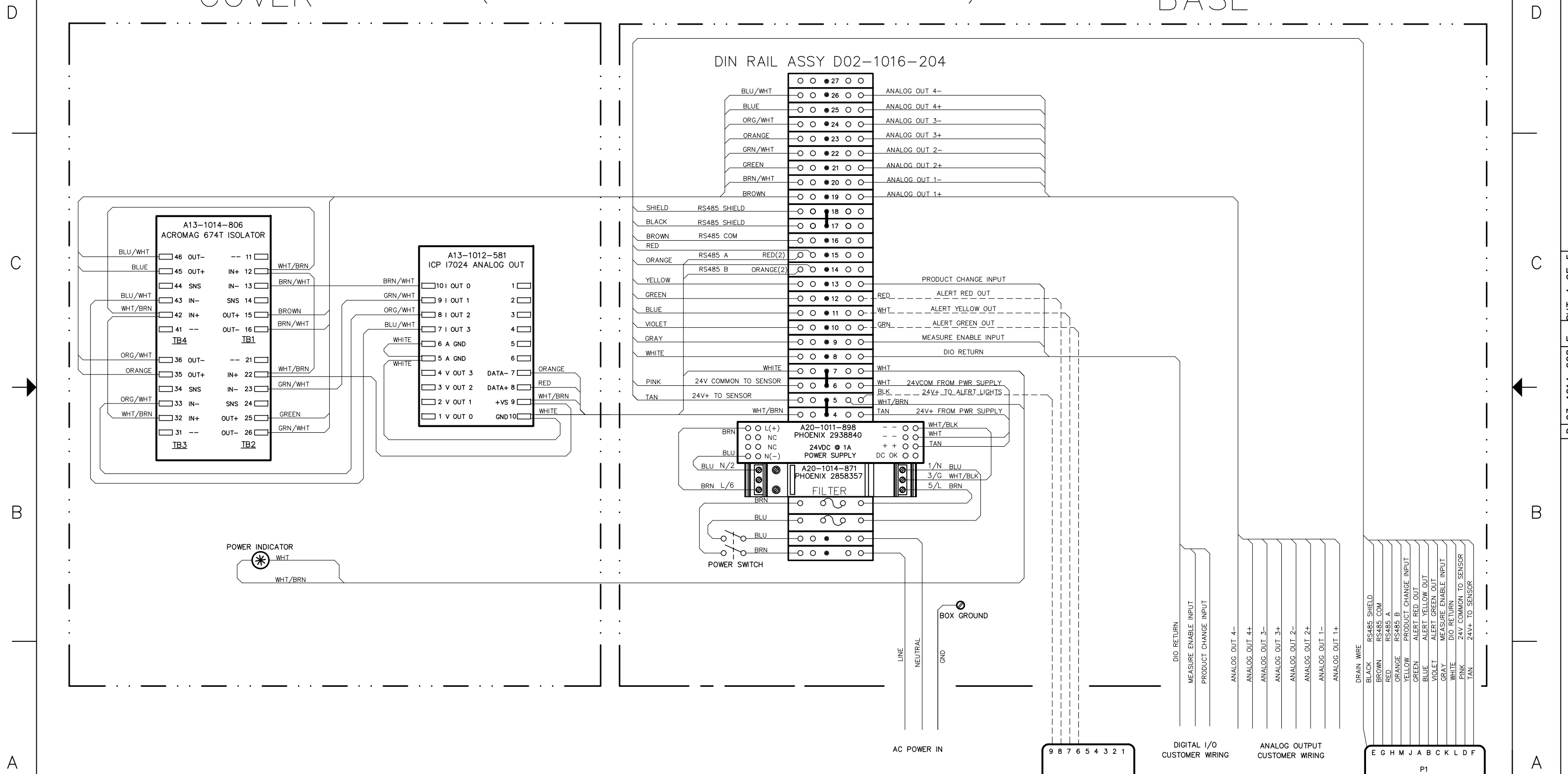

D 03-1014-628 F SHT\_4\_OF\_5

# SUPPORT UNIT W/LENGTH COUNTER

(STANDARD VERSION D02-1014-823)

REVISIONS				
ZONE	REV	DESCRIPTION	DATE	APPROVED
		SEE SHEET 1 FOR REVISION DESCRIPTION		

COVER

BASE

